



2026-2027 INNO SYSTEM CARRIER CATALOG



What's in a name? If that name happens to be INNO, it stands for nearly 40 years of designing and manufacturing the most INNOvative and technologically advanced car racks for active sports enthusiasts.

Founded in 1966 by Takaaki Murata, the inventor of the car seat headrest, Car Mate is today the largest manufacturer of automotive accessories in Japan. The company's car rack division was launched in 1976. Today INNO has almost a 60% share of the Japanese car rack market, with our own manufacturing facilities in Japan, China and the USA to keep up with the growing demand.

The breadth of our premium quality car racks and cargo systems are the result of decades of industry experience within the automotive accessory and rack business. Car Mate USA, Inc., is a wholly owned subsidiary of Car Mate Mfg. Co., Ltd. of Tokyo, Japan, doing business as INNO Advanced Car Racks. Car Mate is a publicly traded company on the JASDAQ (STANDARD) in Japanese stock market.



INNO first appeared in the U.S. market in 2003. Not surprisingly, our racks have caught on quickly in the States and are considered an ideal match for the nation's growing legions of active "weekend warriors" and professional athletes who demand technological superiority. No other company tests its racks as thoroughly or as vigorously to make sure that they protect the cargo and the vehicle in what can often be harsh conditions. From our testing labs with UV-ray and salt spray testing booths to the race track designed for automotive manufacturers that we have used for real-world high speed testing, we take your safety and your investment in your gear seriously. Our attention to detail is what has made us different from other competitors. All of our products are backed by an industry leading warranty.

INNO's greatest INNOvation is quality and reliability that you can trust to protect you, your car, and your cargo.



Aero Base Rack Systems
04 ~ 05

Through Bar Type
06

Flush Bar Type
07

Square Base Rack Systems
08 ~ 09

Quick Lock Systems
10 ~ 14

Bike-Hitch Mount & Roof Top
15 ~ 19

Truck Bed Mounts
18

Cargo Boxes
20 ~ 29

Water Sports
30 ~ 31

Camping
32 ~ 34

Snow Racks
35

Fishing
36 ~ 39

Introduction To Your System Carrier

INNO's Universal Mounting Systems (UMS) offers various attachments that are directly compatible with aero, square, round and most factory cross bars perfect for all your gear.

Attachments (1)

Whether you are a sports enthusiast or a traveler of the open road, one must think how to carry their gear. INNO ATTACHMENTS do just that, allowing you to carry your bikes, water sports or winter sports equipment and more- or just stow extra baggage and equipment in a cargo box. All INNO ATTACHMENTS include universal mounts, fitting most factory and aftermarket cross bars.



Aero Base Rack Systems (2)

INNO's aerodynamic AERO BASE RACK SYSTEMS feature a solid black scratch resistant coated low profile design. Systems available for Flush Bars and Through Bars.



Base Rack Systems (3)

BASE RACK SYSTEMS are a combination of several items including; STAYS, CROSS BARS, and FIT KITS (vehicle dependent) creating a BASE RACK SYSTEM for your vehicle. Installation of a BASE RACK SYSTEM allows the use of ATTACHMENTS to be mounted to your vehicle.

To select the correct BASE RACK SYSTEM for your vehicle please visit our fit guide on the INNO website: <https://usa.innoracks.com>



Stays (4)

STAYS support different vehicle roof styles; smooth, raised side rails, track, and fixed point, allowing cross bars to be mounted securely. STAYS come as a set of four with locks and keys included.

Cross Bars (5)

Cross Bars are made of square hardened steel and elastomeric coating to resist corrosion, offering superior strength. CROSS BARS are available in eight different lengths offering the best look and fit for your vehicle.

Fit Kits (6)

Newly redesigned fit kits fit even better to each vehicle. FIT KITS may include any of the following to support your vehicle configuration: hooks, pads, brackets, covers, and assembly parts. FIT KITS work in conjunction with the STAYS supporting smooth roof, track, and fixed point BASE RACK SYSTEMS.



AERO BASE RACK SYSTEMS

New aerodynamic AERO BASE RACK SYSTEMS feature a solid black scratch resistant coated low profile design for a quiet ride and improved fuel economy Systems available for Flush Bars and Through Bars.

Through Bar Type

EZ-Mount

Secure And Easy Installation

Fine Finish Bar

Scratch Resistant Blasted Black Finish

Non-Cut Rubber

EZ-Slide Coated Non-Cut Trim

Quiet Ride

*20% Less Wind Noise Compared to INNO Square Bars

Aerodynamic, Reduced Height Design*

Aerodynamic, Reduced Height Design Low Profile Stay (*Excluding XS250). Aerodynamically Shaped Bar



*According To Internal Test Data Compared To INNO Square Bars



XS150
For Raised Rail



XS250
For Smooth Roof



XS350
For Fixed Points



XS450
For Flush Rail

Aero Base Rack Systems

For raised rail, smooth roof, fixed points, and flush rail style vehicles

- Glass Blasted Black Finish
- Low profile design for quiet ride and improved fuel economy
- Scratch resistant coating
- Locks and keys Included



Available Lengths:

XB85: 33in. Black	XB108: 42in. Black	XB130: 51in. Black	XB153: 60in. Black
XB93: 36in. Black	XB115: 45in. Black	XB138: 54in. Black	XB160: 63in. Black
XB100: 39in. Black	XB123: 48in. Black	XB145: 57in. Black	

- (Fig.1) The mold for filling the T-SLOT has double structures, the elastic base section and the smooth surface, which simplifies the positioning of the mounting bolts.
- (Fig.2) To fix the mounting bolts, just remove the stay cover / end cap, insert them into the T-SLOT, and slide.



Fig.1



Fig.2

AERO BASE RACK SYSTEMS



Flush Bar Type

EZ-Mount

Secure And Easy Installation

Fine Finish Bar

Scratch Resistant Blasted Black Finish

Non-Cut Rubber

EZ-Slide Coated Non-Cut Trim

Quiet Ride

*20% Less Wind Noise Compared to INNO Square Bars

Aerodynamic, Low Down Design

Aerodynamic, Reduced Height Design. Aerodynamically Shaped Bar and Low Profile Stay



*According To Internal Test Data Compared To INNO Square Bars



XS100
For Raised Rail



XS201
For Smooth Roof



XS300
For Fixed Points



XS400
For Flush Rail

Low Profile

A stylish look made possible by lowering the bar height to the limit

Aero Base (Flush Bar)

Square Base

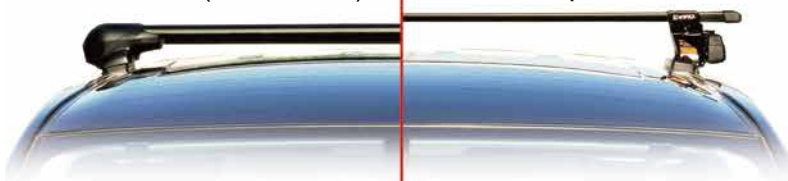

Height of XS201 is lower than IN-SUT

Installed example: Toyota Minivan

Bar End

Bar extension is eliminated to create a sense of integration

Aero Base

Square Base

Installed example: Toyota Minivan



Through Bar Type

XS150

For vehicles with raised side rails

- XS150 (Black)
- Rubber coated stainless steel straps
- Locks and keys included
- Set of 4



XS250

For smooth roof vehicles without rain gutters

- XS250 (Black)
- Locks and keys included
- Requires the appropriate Fit Kit
- Set of 4



XS350

For vehicles with factory track systems and fixed points

- XS350 (Black)
- Locks and keys included
- Requires the appropriate Fit Kit
- Set of 4



XS450

For vehicles with flush rails

- XS450 (Black)
- Locks and keys included
- Requires the appropriate Fit Kit
- Set of 4



XS250 System Shown

Flush Bar Type

XS100

For vehicles with raised side rails

- XS100 (Black)
- Rubber coated stainless steel straps
- Locks and keys included
- Set of 4



XS201

For smooth roof vehicles without rain gutters

- XS201 (Black)
- Locks and keys included
- Requires the appropriate Fit Kit
- Set of 4



XS300

For vehicles with factory track systems and fixed points

- XS300 (Black)
- Locks and keys included
- Requires the appropriate Fit Kit
- Set of 4



XS400

For vehicles with flush rails

- XS400 (Black)
- Locks and keys included
- Requires the appropriate Fit Kit
- Set of 4



- EZ-slide Plastic Coated & Non-cut Trim



- Scratch Resistant Bar
- Glass Blasted Black Finish

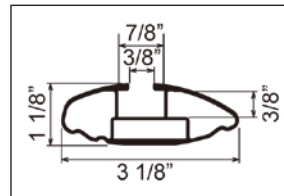

- Wing Shaped Aero Bar
- Reduced Wind Noise Over Other Systems
- Better Fuel Economy



- No Tools Required for XS100/150 Only
- Double Threaded Screw for Easier and Faster Installation for XS100 /150 Only



- Locks and Keys Included



- Greater Fitting Range: Fits Side Rail Circumference 2 3/4" to 8" XS100/150 Only



- Torque Indicator for XS201/250/400/450 to Prevent Over Tightening



- Bar-End Stop for Added Safety

SQUARE BASE RACK SYSTEMS

INSUT

For smooth roof vehicles without rain gutters

- IN-SUT (Black)
- Torque control knob for preventing overtightening
- Locks and keys included
- Requires the appropriate Fit Kit
- Set of 4



IN-FR

For vehicles with raised rails

- IN-FR (Black)
- Rubber coated stainless steel straps
- Locks and keys included
- Set of 4



IN-XP

For vehicles with factory track systems and fixed points

- IN-XP (Black)
- Newly redesigned larger lever for easier installation
- Locks and keys included
- Requires the appropriate Fit Kit
- Set of 4



IN-TR

For vehicles with unique track systems and mounting points

- IN-TR(Black)
- Locks and keys included
- Requires the appropriate Fit Kit
- Set of 4



IN-XR

For vehicles with factory track systems and fixed points

- IN-XR (Silver)
- Locks and keys included
- Requires the appropriate Fit Kit
- Set of 4



SQUARE BASE RACK SYSTEMS

With Rain Gutters

For vehicles with rain gutters

- IN-LDK / SDK / MDK (Black)
- Locks and keys included
- Set of 4

Available Heights:



Square Bars

- Black
- Made of hardened steel with elastomeric coating
- Square profile
- Dimensions: width 0.9in (23mm) x height 1.3in (32mm)
- Set of 2

Available Lengths:

IN-B107: 42in. ; IN-B117: 46in. ; IN-B127: 50in. ;
 IN-B137: 54in. ; IN-B147: 58in. ; IN-B165: 65in. ;
 IN-434A: 71in. ; IN-436L: 79in.



IN-JK

Joint Bar for IN-SUT Stay

- IN-JK(Black)
- Requires IN-SU / SUT rack system
- Creates a stronger and more stable platform
- Set of 2



Fairing (Universal Mount)

- INA260/261/262 (Black)
- INA270/271/272 (Carbon look)
- Universal mounting system, fits aero, square, round and most factory cross bars
- Made of strong durable 3 layer ABS plastic
- Reduces wind noise at high speeds
- Aerodynamic design for better fuel economy



Black



Carbon look

	Available Widths	Recommended installation measurements
INA260 / INA270	Small	W31" x H4.5"
INA261 / INA271	Med	W40" x H4.5"
INA262 / INA272	Large	W48" x H4.5"



QUICK LOCK SYSTEMS

Newly released all new quick base system offers more versatility in storage and bike transportation needs. Designed for easy transition from the compact Gear Carry to larger Gear Box to the 2-bike rack, offering three options to store all your gear needs.

For Rear hitch

INH10

QUICK BASE TRAY FOR HITCH

- Usable rear tray for loading gears and foldable when not in use.
- Fits 2" receivers
- Tray dimension: L 39.5" x W 25.6" x H 5"
- Max weight: 150 lbs.
- Product weight: 35.5 lbs.
- Locks and keys included



For Roof and Truck Bed

INQ10

QUICK BASE TRAY FOR ROOF & TRUCK BED

- Universal Mounting System, fitting mounts to square and most factory cross bars.
- Size L 39.5" x W 25.6" x H 5"
- Max weight: 150 lbs.
- Product weight: 13 lbs.
- Locks and keys included



INQ60

QUICK BASE FOR ROOF & TRUCK BED

- Fits C channel and Square crossbars
- Size L 39.5" x W 25.6" x H 5"
- Product weight: 7.3 lbs.
- Locks and keys included



QUICK LOCK SYSTEMS



INH10 + BRL310MBK



INQ10 + BRL160MBK



INH10



INH10



INH10 + BRL160MBK



INH10 + BRL310MBK



INQ10



INQ10 + BRL160MBK



INQ10 + BRL310MBK

Quick Lock Systems Line Up

ROOF



Tray for any cases



Wheeled Box



Cargo Box



Bike



Ski & Snowboard

HITCH



Quick Lock Modular Systems

Cargo Boxes



BRL160



GEAR CARRY

- BRL160MBK (Matte Black)
- This innovative compact cargo box can be quickly removed from the roof top or rear hitch and easily transported to your favorite location.
- Take all the gear in the box to your favorite location with the large wheels
- Easy installation and lock with the levers on the Quick Base, INH10, INQ10 or INQ60 (sold separately)
- Safety lock system and keys and lock included.
- Exterior dimensions: 44.5" x 28" x 11" (113 x 71 x 28 cm)
- Interior dimensions: 40" x 22" x 9.75" (101 x 56 x 25 cm)
- Capacity: 6 cubic feet
- Weight: 19 lbs.



BRL310

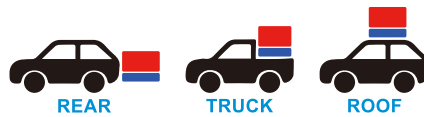

GEAR BOX

- BRL310MBK (Matte Black)
- Larger size box will fit much more of your gear and installed quickly on the rear, roof or truck bed with the Quick base
- Easy installation and lock with the levers on the Quick Base, INH10, INQ10 or INQ60 (sold separately)
- Exterior dimensions: 63.5" x 28" x 15.75" (161 x 71 x 40 cm)
- Interior dimensions: 57" x 23.5" x 14.75" (145 x 60 x 37.6 cm)
- Capacity: 11 cubic feet
- Weight: 25 lbs.



QUICK LOCK SYSTEMS

Bike

INL300



INH10 + INL300



INQ10 + INL300



Two Bike Trays

- E-bike capability (Carry up to 120 lbs)
- Easy installation and lock with the levers on the Quick Base
- Carrier secures bike without touching bike frame or forks
- Foldable trays when not in use

Capacity

- Tire size: 20" - 29"
- Tire width: 18c - 3.5"
- Wheel base: 34" - 51"



Snow

IOP90



INH10 + IOP90 + INA952



Ski / Snowboard Adaptor

- Adaptor to attach INA952 to INH10/INQ10
- 3 fat skis or 2 snowboards

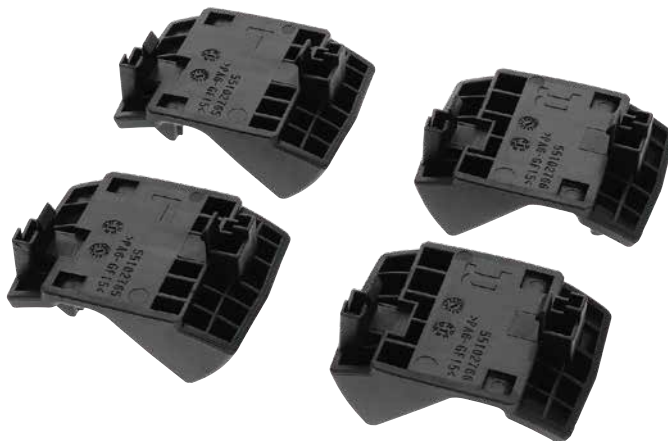

Bike



INH110 / INH120 / INH142

TIRE HOLD BIKE HITCH

- INH110 (1 Bike), INH120 (2 Bike), INH142 (4 Bike)
- E-bike capability (Each tray can carry up to 60 lbs. Max total of INH142 is 160 lbs.)
- Carrier secures bike without touching bike frame or forks
- Good for carbon frames, large size fork and 27.5" semi fat bikes
- Foldable trays when not in use
- Trays tilt down to allow access to trunk with a lever



Capacity

- Tire size: 20" - 29"
- Tire width: 18c - 3.5"
- Wheel base: 34" - 48"



INH110

- 1 Bike
- Fits 1 1/4" and 2" receivers
- Max weight 60 lbs.
- Product weight 30.8 lbs.

INH120

- 2 Bike
- Fits 1 1/4" and 2" receivers
- Max weight 120 lbs.
- Product weight 48.5 lbs.

INH142

- 4 Bike
- Fits only 2" receiver
- Max weight 160 lbs.
- Product weight 84.9 lbs.





INH123 (2 Bikes)

TIRE HOLD HITCH RACK HD 2

Designed for most heavy bikes like E-bikes.
 Each tray can carry up to 80 lbs.
 Max total is 150 lbs.
 To make easier to load heavy bikes,
 IOP20 Ramp option is available.

- Carrier secures bike without touching bike frame or forks
- Good for carbon frames, large size fork and 27.5" semi fat bikes
- Foldable trays when not in use
- Trays tilt down to allow access to trunk with a lever
- Fits 2" receiver only

• 2 bike
 Product weight: 53 lbs.

Capacity

- Tire size: 20" - 29"
- Tire width: 18c - 5"
- Tire Wheel base: 34" - 51"



IOP20

Ramp option for INH123

- Easy to load even heavy E-bike
- Loading capacity: 80 lbs.
- Product weight: 5 lbs.



IOP21

Fender option for INH123

- Can carry bike with fender
- Capacity
- Tire size: 20" - 26"
 - Tire width: 18c - 5"
 - Tire Wheel base: 34" - 51"
 - Strap included

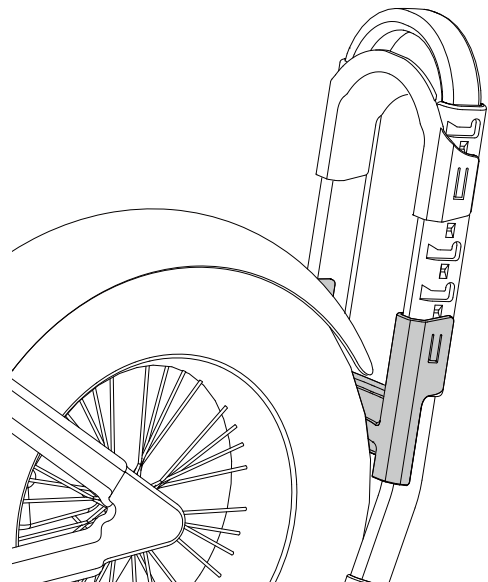

TRUCK BED MOUNTS / BIKE

RT201 / RT202

Velo Gripper

Put your bike in the bed of your truck without sacrificing precious cargo space with our new Velo Gripper bike mount.

- RT201 (1 bike capacity, Standard truck beds)
- RT202 (1 bike capacity, C-channel track systems)
- Does not require front tire removal
- Works with all types of bikes
- These items work with standard bike cable locks (not included)

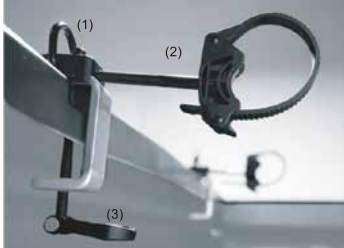

RT201

- (1) Comes with D-ring for tie down straps
- (2) Ratcheting fork holder
- (3) No tools required and no holes to drill



RT202

RT101 / RT102

Truck Stay

- RT101 Standard Truck
- RT102 C-Channel Truck
- Designed for trucks with standard truck beds (RT101) or C-channel track systems (RT102)
- Allows mounting of attachments above the truck bed
- Compatible with square or round bars
- Silver
- Easy mount
- No holes to drill
- Set of 4



RT101



RT102



RT101



RT102

INA389

Tire Hold 2

- INA389 Black (1 bike capacity)
- Newly Improved Tire Size adjuster for faster and easier Tire Size Adjustment
- Carrier secures bike without touching bike frame or cable brake systems
- No tools required
- Universal Mounting System, fitting to aero, square, round, and most factory cross bars
- Supports most bike frame styles
- Supported tire sizes: 20", 22"-24", 26"-27.5", 700c, 29" max. tire width 2.7"
- Locking rear ratchet tire holder
- A lock, keys and locking bike cable included

Only 3 Steps To Secure Your Bike

- (1) Open the arms
- (2) The bike drops into the front arm using "Self-Standing Auto System"
- (3) Rear ratcheting arm secures and locks bike into position



INA391

Fork Lock III

- INA391 (Silver)
- 1 bike capacity
- Universal Mounting System, fitting to aero, square, round and most factory cross bars
- Compatible with disc brakes
- Front fork holder with clutch tightening adjuster
- Oversize quick release handle allowing more leverage for small hands
- No tools required
- Locks and keys included
- Able to be mounted with the general quick release bikes with a fork width of 100mm and an axle shaft of 9mm
- Compatible with standard forks with 100mm spacing and 9mm quick release



INA394

Multi Fork Lock

- INA394 (Matte Black)
- 1 bike capacity
- All-in-one compatibility fitting 9mm, 12mm, 15mm, and 20mm thru-axle bikes, includes "Boost" type

- Fits up to 1300mm (51") wheel base
- All new thru-axle compatible for three size axles

- Universal Mounting System, fitting to aero, square, round and most factory cross bars
- The multi cradle is compatible with MTB and road bike tires
- Frame made of light weight Aluminum
- The carrier comes with anti-theft QR guard (Fig.1)

- A new model of asymmetry design
- Compatible with disc brakes
- Adaptors for 9mm, 12mm, 15mm, and 20mm thru-axle, includes "Boost" type
- No tools required
- Locks and keys included



(Fig.1)



For MTB



For Road Bike

Cargo Boxes



Phantom, Wedge and Shadow Series

INNOvative technology and advanced materials that reduce weight and maximize strength. Aerodynamic design for superior noise reduction. Stiffer base for stability.

- Dual side opening for easy loading
- Ample storage capacity
- User friendly locking mechanism for single handed opening
- Universal Mounting System, fitting mounts to square, round and most factory cross bars

Technology

Utilizing technology that has been proven in Automotive Manufacturing, the SPM process of injection molding produces the most innovative cargo box.

- Injection mold SPM process creates strong, durable, light-weight forming structures.
- An ideal combination of Press-forming and Injection-molding creating uniform thickness throughout.
- SPM integrated Servo-direct controls produce extraordinary product stability.
- Extra-low injection speed allows for increased forming structure, improving body stiffness and reducing torque.
- Up to 50% stronger than conventional Vacuum-forming

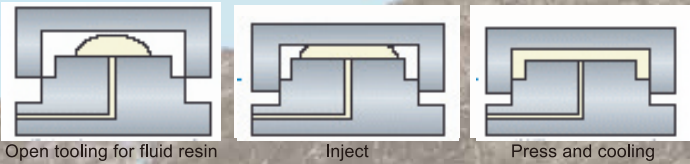

Q Quick Mount

- Universal Mounting System, fitting mounts to square, round and most factory cross bars (Fig.1)
- No tools required (Fig.2)
- Cross Bar height adjustment (Fig.3)



Fig.1



Fig.2



Fig.3

M Memory Mount

Memory Mount allows you to install or remove a cargo box in seconds making the use of the cargo box hassle free.

- Universal Mounting System, fitting mounts to square, round and most factory cross bars (Fig.1)
- Low profile maximizing the interior storage capacity of your cargo box
- No tools required
- Removable mounts reducing the chance of damage when storing the cargo box. (Fig.2)
- Built-in quick wheel adjustment for a secure fit to the cross bar (Fig.3)



Fig.1



Fig.2



Fig.3





BRM2020

ROOF BOX 2020

- BRM2020ST (Matte Black)
- 4-6 Snowboards or 6-8 Skis
- 14 cubic feet capacity
- Dual-side opening for easy loading
- Memory Mount System **M**
- Universal Mounting System, fitting to aero, square, round, and most factory cross bars

- Safety lock system – key can only be removed once box is locked
- Locks and keys included
- Top and Bottom covers are processed with SPM, creating robust, durable, light-weight forming structures
- BRP15 (3D Inner Mat) and BRP12 (T-slot adaptor) are compatible.



M Matte Black (BRM2020ST)



100% Recycled Materials

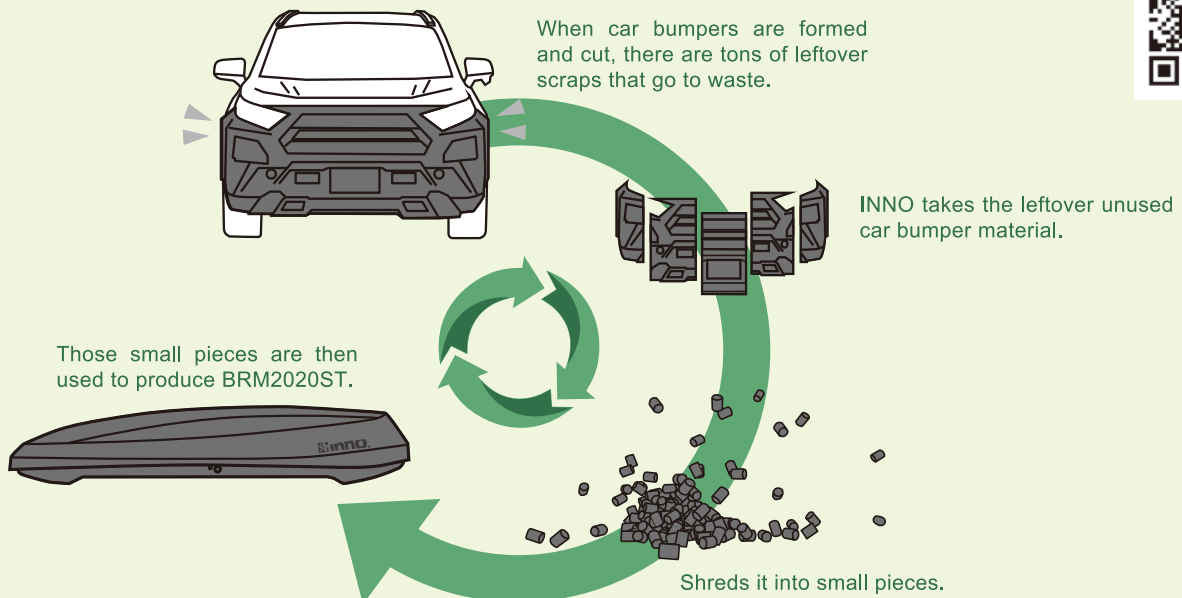

CARGO BOXES



1



2 3



4



5



6



7

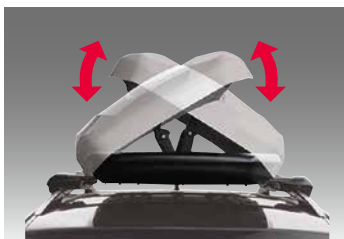

8



Features

1. Wide and low style that enhances the sense of unity with the vehicle
2. Adopts straight lines, a trend in car design
3. Rear edge design that is difficult to achieve with normal molding
4. Diffuser design that regulates the airflow at the bottom and exhausts it efficiently
5. Side handle that makes it easy to open and close the cover
6. New safety lock system that automatically locks the cover in two places when closed
7. Dual opening that can be opened and closed from both the left and right sides
8. Memory clamp that makes it easy to attach and remove from the base carrier

BRM850

ROOF BOX 850

- BRM850BK (Gloss Black)
- 4-6 Snowboards or 8 Skis
- 14 cubic feet capacity
- Dual-side opening for easy loading
- Memory Mount System
- Universal Mounting System, fitting to aero, square, round, and most factory cross bars
- Safety lock system - key can only be removed once box is locked
- Locks and keys included



M Gloss Black (BRM850BK)

BRM855

ROOF BOX 855

- BRM855BK (Gloss Black)
- 6-8 Snowboards or 8-10 Skis
- Loadable up to 80" (203 cm)
- 17 cubic feet capacity
- Dual-side opening for easy loading
- Memory Mount System
- Universal Mounting System, fitting to aero, square, round, and most factory cross bars
- Safety lock system - key can only be removed once box is locked
- Locks and keys included



M Gloss Black (BRM855BK)





BRM720

ROOF GEAR CASE 720

- BRM720MBK (Matte Black)
- BRM720BG (Matte Beige)
- Rugged Cargo Box for SUV
- One side opening
- 4 Snowboards or 6-8 Skis
- 11.5 cubic feet capacity
- Memory Mount System
- Universal Mounting System, fitting to aero, square, round, and most factory cross bars
- Locks and keys included



M Matte Black (BRM720MBK)



M Matte Beige (BRM720BG)





Features

1. Low profile with square design for larger capacity
2. Rugged design for high durability
3. Side handle for easy opening / closing and carrying
4. Bumper protects cargo box itself and it enables cargo box to be stored against a wall
5. Lever clamp with key lock system
6. Memory Mount System
7. Strap included



BRM715

ROOF GEAR CASE 715

- BRM715MBK (Matte Black)
- Rugged Cargo Box for SUV
- Slim, low-profile design with a square shape
- Slim design can accommodate multiple attachments on the cross bar
- The base is a flat shape, allowing it to be attached to the T-slots of the roof rack by using a T-slot adapter (BRP12, sold separately).
- One side opening
- 2-3 Snowboards or 3-4 Skis
- 8 cubic feet capacity
- Memory Mount System
- Universal Mounting System, fitting to aero, square, round, and most factory cross bars
- Locks and keys included



M Gloss Black (BRM715MBK)



CARGO BOXES

BRM865

INNO WEDGE Plus

- BRM865MBK (Matte Black)
- 4-6 Snowboards or 6-8 Skis
- 13 cubic feet capacity
- Dual-side opening for easy loading
- BRP15 (3D Inner Mat) and BRP12 (T-slot adaptor) are compatible.
- Memory Mount System **M**
- Universal Mounting System, fitting to aero, square, round, and most factory cross bars
- Safety lock system – key can only be removed once box is locked
- Locks and keys included



M Matte Black (BRM865MBK)



BRM660

INNO WEGDE 660

- BRM660BK (Gloss Black)
- BRM660WH (Gloss White)
- 4 Snowboards or 6-8 Skis
- 11 cubic feet capacity
- Dual-side opening for easy loading
- BRP15 (3D Inner Mat) and BRP12 (T-slot adaptor) are compatible.
- Memory Mount System **M**
- Universal Mounting System, fitting to aero, square, round, and most factory cross bars
- Safety lock system – key can only be removed once box is locked
- Locks and keys included



M Gloss Black (BRM660BK)



M Gloss White (BRM660WH)



BRM320

INNO ROOF BOX 320

- BRM320MBK (Matte Black)
- 4 Snowboards, or 6-8 Skis
- 9 cubic feet capacity
- Dual-side opening for easy loading
- BRP12 (T-slot adaptor) is compatible.
- Memory Mount System **M**
- Universal Mounting System, fitting to aero, square, round and most factory cross bars
- Safety lock system – key can only be removed once box is locked
- Locks and keys included



M Matte Black (BRM320MBK)



BRM466

INNO PHANTOM 466

- BRM466BK (Gloss Black)
- 4-8 Snowboards or 8-10 Skis
- 18 cubic feet capacity
- Dual-side opening for easy loading
- Memory Mount System

- Universal Mounting System, fitting to aero, square, round, and most factory cross bars
- Safety lock system - key can only be removed once box is locked
- Locks and keys included



M Gloss Black (BRM466BK)



BRA240

INNO RIDGEBOX

- BRA240BK (Gloss Black)
- 8 cubic feet capacity
- Passenger-side opening for easy loading
- Compact size smaller vehicles with square style finish allows more cargo space

- U-bolt Mount System **U**
- Universal Mounting System, fitting to aero, square, round and most factory cross bars
- Safety lock system - key can only be removed once box is locked
- Locks and keys included



U Gloss Black (BRA240BK)



BRP15

3D Inner Mat

- Reduced noise, gear protection and easy care



Available for: BRM660 / BRM665 / BRM864 / BRM865
BRM2020 / BRA1210 / BRA1150

BRP12

T-Slot Adaptor

- Stylish installation is assured with the unexposed mounting bracket.

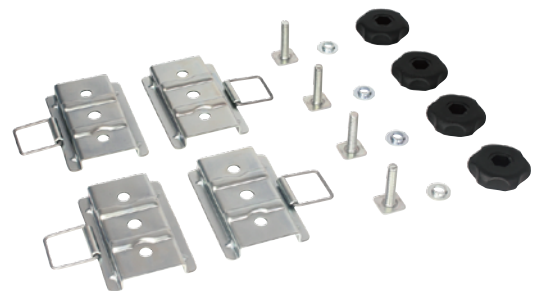

Available for: BRM320 / BRM624 / BRM625 / BRM660
BRM665 / BRM864 / BRM850 / BRM855
BRM865 / BRA1110 / BRA1150
BRA1210 / BRA1250 / BRA1450
BRA1850 / BRM2020 / BRM720

CARGO BOXES

CARRIER ATTACHMENT Cargo Boxes Line Up



BRM855BK



BRM850BK



BRM720MBK















BRM466BK



BRM865MBK



BRM320MBK

		Exterior Dimensions [Height from bar]	Interior Dimensions	Capacity	Weight
	BRM855	84.25" x 38.5" x 14.5" [13inch] (214 x 98 x 36.5 cm)	77.25" x 30.75" x 11.5" (196 x 78 x 29 cm)	17 cu.ft.	53 lbs.
	BRM850	80.75" x 38.5" x 12.5" [11inch] (205 x 98 x 32 cm)	73.25" x 30.75" x 10.25" (186 x 78 x 26 cm)	14 cu.ft.	49 lbs.
	BRM720	72.75"X34.25"X12" [11inch] (185x87x30.5 cm)	65.5" x 28.75" x 9.75" (166.5x73x24.5cm)	11.5 cu.ft.	33 lbs.
	BRM466	78.75"X37.5"X17.75" [16.25inch] (200x95x45cm)	73.25"X31"X15" (186x79x38cm)	18 cu.ft.	49 lbs.
	BRM865	80.75"X33"X13.5" [12inch] (205x84x34 cm)	72"X25.5"X11" (183x65x28cm)	13 cu.ft.	47 lbs.
	BRM320	71.25"X32"X10.75" [9.25inch] (181x81.5x27cm)	66.25"X25.5"X8" (168x65x20.5cm)	9 cu.ft.	37 lbs.
	BRM2020	78.75" x 32.5" x 15.25" [13.75inch] (200 x 83 x 38.5 cm)	72"X25.5"X12.75" (183x65x32.5cm)	14 cu.ft.	43 lbs.
	BRM660	80"X33"X11" [9.75inch] (203x84x28 cm)	72"X25.5"X8.25" (183x65x21cm)	11 cu.ft.	42 lbs.
	BRM715	79.25"X24"X11" [11inch] (201x61x28 cm)	72.25"X18.5"X9.75" (184x47x25cm)	8 cu.ft.	27 lbs.
	BRA240	55"X27.5"X13.5" [12.25inch] (140x70x34 cm)	50.5"X23.5"X11.5" (128x60x29cm)	8 cu.ft.	20 lbs.
	BRL310+INQ10/INQ60	63.5" x 28" x 17.25" (161 x 71 x 44 cm)	57" x 23.5" x 14.75" (145 x 60 x 37.5 cm)	11 cu.ft.	37 lbs. (INQ10) 32 lbs. (INQ60)
	BRL160+INQ10/INQ60	44.5" x 28" x 12.5" (113 x 71 x 32 cm)	37" x 22" x 9.75" (94 x 56 x 25 cm)	6 cu.ft.	33 lbs. (INQ10) 27 lbs. (INQ60)

* Quantities may vary based on binding size. ** Fits most aftermarket cross bars and factory-installed racks. Check Fit Guide for specific vehicles.
***The distance from the rear mounting place to the rear edge of the cargo box.



BRM2020ST



BRM660BK



BRM715MBK



BRA240BK



BRL310MBK+INQ60



BRL160MBK+INQ60

Box Opening	Crossbar Compatibility	Top Material	Base Construction	Hatch Clearance	Ski Capacity	Snowboard Capacity	Features
Right and Left	Universal **	3-Layer ABS	Vacuum-forming	21" ***	8 - 10	4 - 6	Sleek design, substantial storage
Right and Left	Universal **	3-Layer ABS	Vacuum-forming	22" ***	8 - 10	4 - 6	Low & Wide new sleek design
Single side	Universal **	2-Layer ABS	Vacuum-forming	18.5" ***	6 - 8	4*	Rugged Design
Right and Left	Universal **	3-Layer ABS	Vacuum-forming	20" ***	8 - 10	4 - 8 *	Largest Size
Right and Left	Universal **	3-Layer ABS	SPM Injection	20.75" ***	6 - 8	4 - 6 *	Useful Size
Right and Left	Universal **	2-Layer ABS	SPM Injection	15.75" ***	6 - 8	4*	Square Design
Right and Left	Universal **	SPM Injection	SPM Injection	19.25" ***	6 - 8	4- 6 *	Eco-Friendly Made from recycle
Right and Left	Universal **	3-Layer ABS	SPM Injection	20.5" ***	6 - 8	4 *	Ergonomic Design
Single side	Universal **	2-Layer ABS	Vacuum-forming	17.25" ***	3 - 4	2 - 3 *	Rugged Design
Right	Universal **	3-Layer ABS	Vacuum-forming	12.5" ***	--	--	Perfect fit for sedans and small cars
Single side	INQ10 / INQ60	2-Layer ABS	Vacuum-forming	14.75" ***	--	--	Easy to attach and detach Cargo box
Single side	INQ10 / INQ60	2-Layer ABS	Vacuum-forming	5" ***	--	--	Easy to attach and detach Cargo box with wheels

INA446

Surf / SUP / Kayak / Canoe Locker

- INA446 (Black)
- The ultimate Surf, SUP, Kayak and Canoe rack – and it locks too. Versatility is this racks middle name supporting Kayaks, Canoes, Wind / Paddle / Sail / SUP/ Long and Short surfboards.
- 1 Kayak or 1 Canoe or 2 Wind Surfboards or 3 Shortboards or 2 Longboards or 2 SUP
- Universal Mounting System, fitting to aero, square, round and most factory cross bars.



INA446



Fig.1

Fig.2

Fig.3

- Floating strap system for easy loading
- Ratcheting mechanism for secure tightening (Fig.1, Fig.2)
- Rubber coated stainless steel cable strap
- Board pads included
- Locks and keys included (Fig.3)



XA445

Surf / SUP / Kayak / Canoe Locker for AeroBase

- XA445 (Black)
- 1 Kayak or 1 Canoe or 2 Wind Surfboards or 3 Shortboards or 2 Longboards or 2 SUP
- This attachment can be mounted only to the T-SLOT equipped Aero Base Bar.
- A stylish installation is assured with the unexposed mounting bracket located under the bars



- Floating strap system for easy loading
- Ratcheting mechanism for secure tightening
- Rubber coated stainless steel cable strap
- Board pads sold separately
- Locks and keys included



INA455

Two Kayak Carrier

- INA455 (Black)
- 2 Kayaks
- Easy mount dual kayak carrier
- Universal Mounting System, fitting to aero, square, round and most factory cross bars

- Includes cradles for two kayaks
- Foldable when not in use (Fig.1)
- INA451: Optional cradle set for INA455 (Fig.2)
- Pads and straps included



INA455



Fig.1



Fig.2

INA451



INA452

Multi Cradle

- INA452 (Black)
- 1 Kayak
- Set of 4 cradles for one kayak



- Universal Mounting System, fitting to aero, square, round and most factory cross bars
- Pads and straps included
- Fits most Sit-On-Top kayaks



INA453

Kayak Lifter

- INA453 (Silver)
- Ultimate assist for all kayakers.
- Easy loading assist will help you to load the kayak without leaving a scratch on your car.
- Universal Mounting System, fitting to aero, square, round and most factory cross bars



Board pad (INA772) sold separately

- Release the buckle (Fig.1)
- Push the kayak up with assist of the arm. Turn the kayak around (Fig.2)
- Fold the assist arm (Fig.3)



Fig.1



Fig.2



Fig.3

INA744

Board Locker

The ultimate board carrier for locking boards to your car

- INA744 (Black)
- 3 Shortboards or 2 Longboards
- Universal Mounting System, fitting to aero, square, round and most factory cross bars
- Floating strap system for easy loading



- Ratcheting mechanism for secure tightening (Fig.1)
- Crane keeps straps for easy loading (Fig.2)
- Rubber coated stainless steel cable straps
- Integrated 24 inch padded bar
- Locks and keys included



Fig.1



Fig.2

INA772

Multi Board Pads Carbon

- INA772 (Carbon Fiber)
- Set of 2
- Securely transports sailboard masts or kayak paddles
- Fits perfectly on thicker bars including Aero Bars
- 19 1/2" width



IN551

Bar End Hook

- IN551 (Silver)
- Retractable accessory hook mounts to the end of the crossbar so you can hang your wetsuit, towels and more.



IN690

Car Side Awning(Black x Beige)

- Made with lightweight tent material, the total weight is approximately 17.64 lbs (8kg). Easy installation and removal even by one person.
- The 78.75" × 78.75" inch (200 x 200cm) awning fabric creates a comfortable sheltered space next to your vehicle, protected from the sun and rain.
- Features a durable manual retractable system.
- Includes a slim, water-resistant soft case. Case size: 81" × 4.75" × 2.25" inch (206 x 12 x 6cm).
- Includes INNO Aero Base (Through Type) compatible hardware as standard.
- INNO Aero Base (Flush Type) and INNO Square Base require the separately sold IOP70.
- Pegs and guy ropes are included to prevent the awning from being damaged by wind.



INT501BK

Roof Basket 100

- Fairing equipped to reduce wind noise
- No assembly required
- Customizable options available
- Product weight : 27.1 lbs (12.3 kg)
- Max. Load : 165 lbs (75 kg)
- Product size : 6.00" × 39.5" × 55.25" (150 x 1,000 x 1,400mm)
- Interior Dimensions of upper pipe : 4.25" × 36.75" × 49" (105 x 935 x 1,245mm)
- Floor dimensions for loading boxes: 33.25" × 41.25" (845 x 1,050mm)



IOP70

Awning Bracket for Aero Flush and Square

This bracket is for attaching the INNO car side awning to the Aero Base Flush Type and Square Base.



IOP503

Crossbar for INT501

- Set of 2
- Used as a divider for loads
- Convenient for loading long items
- T-slots allow attachments and options to be installed



IOP504

Side Bars for INT501

- Set of 2
- Add a traction board or other attachments for an outdoor feel
- Load cargo while utilizing the main body's cargo space
- T-slots allow for attachments and options



INA521 / INA522 / INA523

Roof Board

- INA521/522/523 (Black)
- Proposing the future shape of roof decks with an unprecedented design and structure.
- Simply place and secure two boards. Lightweight so one person can set it up.
- Compatible with aero bars and square bars with clamp attachment
- Can be used on just one side. Another attachment can be attached to the other side.
- Hole shape makes it easy to secure container boxes and the like with belts.
- Comes with T-slot rails on the front, back, left and right
- Available size : INA521 (W43.25") / INA522 (W47.25") / INA523 (W51")
- Product weight : INA521 (23 lbs) / INA522 (25 lbs) / INA523 (27 lbs)



- Max Load: 165 lbs.(75 kg)
- Max Load (One piece per side): 110 lbs.(50 kg)



INA521BK
Size: 55" x 43.25" x 26"



INA522BK
Size: 55" x 47.25" x 26"



INA523BK
Size: 55" x 51" x 26"

No assembly required

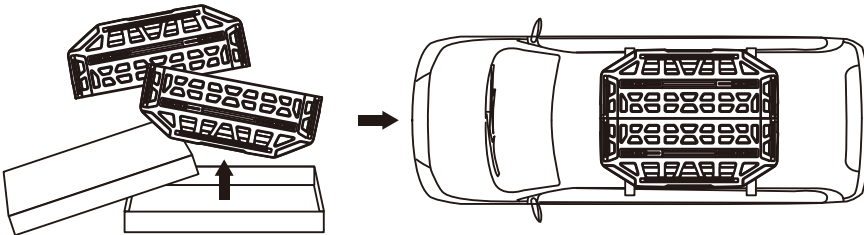

Can be used on just one side

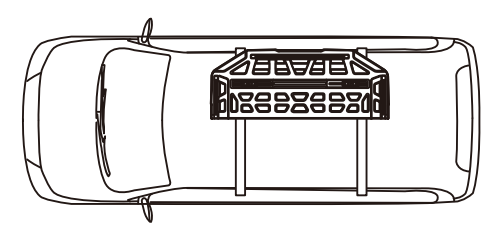

IOP500

T-slot adapter for Roof Board

- Set of 4
- Adapter for mounting Roof Board to T-slots.
- The mounting brackets are not exposed under the base carrier bar.



IOP501

Foldable eye bolt T-slot installation

- Set of 2
- The ring can be tilted
- Compatible with aero bars and square bars with clamp attachment.
- The ring rotates freely even after the bolt is tightened, preventing the belt from twisting and the bolt from loosening.



IOP502

Grab handle T-slot installation

- Set of 2
- Grasp and support the body
- Can also be used to fasten belts



Can be connected



XA801

Multi-rubber band T-slot installation

- Set of 2
- Rubber bands allow easy attachment of oars, skis, shovels and other long objects
- Can also be used with INNO aero bars



INA510

Roof Deck 100

- Universal Mounting System, fitting to aero, square and most factory cross bars
- Easy on and off with Memory universal mount which memorize the first setting
- Product weight: 28.7 lbs. (13kg)
- Max Load: 165 lbs. (75kg)
- Exterior Dimensions - 39.5" x 43.25" x 3" (1,000 x 1,100 x 80mm)
- Interior Dimensions - 35" x 39" x 1" (890 x 990 x 25mm)



INA520

Roof Deck 140

- Universal Mounting System, fitting to aero, square and most factory cross bars
- Easy on and off with Memory universal mount which memorize the first setting
- Product weight: 39.7 lbs. (18kg)
- Max Load: 165 lbs. (75kg)
- Exterior Dimensions - 55" x 55" x 3" (1,400 x 1,400 x 80mm)
- Interior Dimensions - 50.75" x 50.75" x 1" (1,290 x 1,290 x 25mm)



IOP50

Rail Kit for INA510

- Light weight and aluminum construction
- Heavy duty 1 1/4" diameter pipe
- Matte black with Powdercoating finish



IOP51

Rail Kit for INA520

- Light weight and aluminum construction
- Heavy duty 1 1/4" diameter pipe
- Matte black with Powdercoating finish



IOP52

Eye Bolt

- Option for both INA510 / 520 / 530
- Set of 2
- Instant tie down points to secure gear
- Rugged steel construction



INA951 / INA952

- INA951 (6 fat skis or 4 snowboards)
- INA952 (3 fat skis or 2 snowboards)
- Compatible with most cross bars and thick ski bindings
- Universal Mounting System, fitting to aero, square, and most factory cross bars
- Tool-free installation with included hardware
- Constructed of durable plastic and rustproof aluminum



• Easy access from both car sides as the clamps adjust (INA951)

• Wide cradle jaws hold fat skis & system bindings

• Easy on and off with Memory Universal Mount

• Fitting to Aero, Square and most factory cross bars

• Includes lock and keys

Accessory Adaptors*

*Not Required For All Installations

Appropriate crossbar size

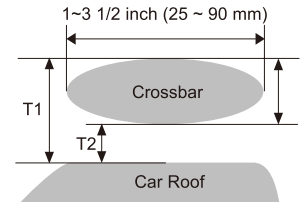

Loading Items	Item No.	H: Crossbar Height		Required Parts		T: Car roof - Crossbar (Minimum)
		Max with provided bolt	In case to use parts	Long bolt kit	Round bar adaptor	
Ski / Snowboard	INA951 / INA952	7/8" ~ 1 3/8" (23 mm ~ 35 mm)	—	—	—	T1: 2 1/8" (55 mm) T2: 1" (25 mm)
Bike	INA389	5/8" ~ 1 1/8" (15 mm ~ 30 mm)	~ 2" (~ 50 mm)	ISF727	—	T1: 2 3/8" (60 mm) T2: 1 1/8" (30 mm)
	INA391			ISF725		T1: 2 3/4" (70 mm) T2: 1 5/8" (40 mm)
	INA392 / INA394	~ 1 3/4" (~ 45 mm)	—	—	—	T2: 3/4" (20 mm)
Surfboard	INA744	~ 1" (~ 25 mm)	~ 2" (~ 50 mm)	ISF711	ISF715	T1: 2 1/8" (55 mm) T2: 1 1/8" (30 mm)
Canoe / Kayak	INA446	~ 1 1/8" (~ 30 mm)	~ 2" (~ 50 mm)	ISF722	—	T1: 2 1/2" (65 mm) T2: 1 3/8" (35 mm)
Kayak	INA451	~ 1 1/8" (~ 30 mm)	~ 2" (~ 50 mm)	ISF716	—	T1: 2 1/8" (55 mm) T2: 1 1/8" (30 mm)
	INA452			ISF716 x 2		
	INA455	~ 1 1/8" (~ 30 mm)	~ 2" (~ 50 mm)	ISF722 & ISF716 x 2	ISF729	T1: 2 1/2" (65 mm) T2: 1 3/8" (35 mm)
Kayak Lifter	INA453	3/8" ~ 1 1/8" (16 mm ~ 30 mm)	—	—	—	T1: 2 3/4" (70 mm) T2: 1 3/4" (45 mm)
Roof Deck	INA510 / INA520	3/4" ~ 1 3/8" (20 mm ~ 35 mm)	—	—	—	T1: 2 1/8" (55 mm) T2: 1" (25 mm)
Fairing	INA260 / INA261 / INA262 INA270 / INA271 / INA272	5/8" ~ 1" * (5 mm ~ 25 mm)	~ 2" (~ 50 mm)	ISF717	—	T1: 2 3/8" ~ 5 1/8" (60 mm ~ 130 mm) T2: 1 1/8" (30 mm)

Rod Case

Strong and light hard case that meets the wide range of demands of expedition anglers, from pack rods to 7 feet.

Although advances in manufacturing technology have made expeditions more convenient with more high-performance packrods, size and weight are very important factors, as there are restrictions on the size and weight of free checked luggage on airplanes. Protects rods to their destination even in harsh conditions where they can be thrown or stacked while on the move.



ROD CASE J

Rod Case J itself is designed to be the optimum size for storing pack rods with a finished length of 39.8" or less. The effective internal dimensions of the cross section are 4.1" x 5.1". By connecting an Add-on Case (sold separately), the length can be changed like a stacking point pencils.

Rod Case J IF45SG (sage green)

Width 5.1" x Height 7.9" x Length 40.6"
3 Sides total 53.5"
Weight 3.5 lbs

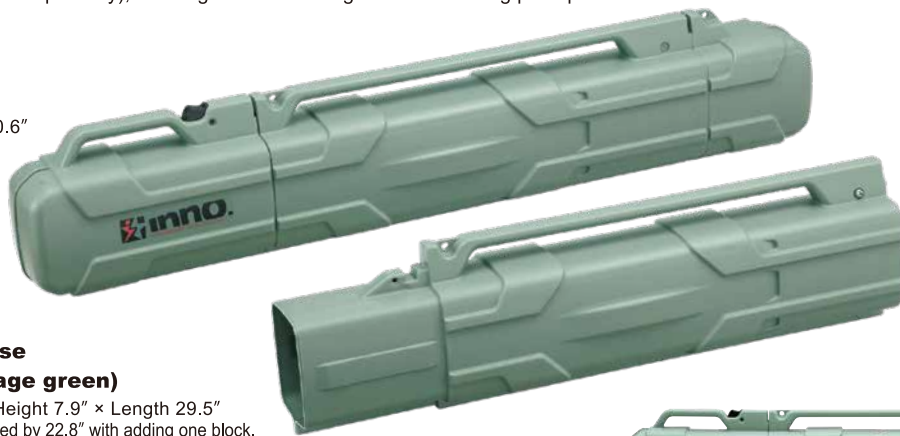

Add-on Case IF46SG (sage green)

Width 5.1" x Height 7.9" x Length 29.5"
It can be extended by 22.8" with adding one block.
Weight 2 lbs



Rod Case J unit total length 40.6". Storable rod length: 39.8"



Using 1 Add-on Case total length: 63.4". Storable rod length: 62.6". Approximate 10 ft 2 pieces



Using 2 Add-on Case total length: 86.2". Storable rod length: 85.4". Approximate 7 ft 1 piece



Two screws connect rod case J to Add-on Case



The cap opens and closes at the touch of a button.

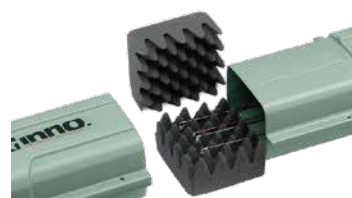

A protective cushion that protects the rod tip. It can also be installed on the top surface of the lid or the bottom surface of the bottom.



Commercially available padlocks or TSA locks can be used by using 5 mm diameter hole across cap and body.



Rod Case J storage example

7' to 8'6" offshore spinning 4 piece x 5, 5'5" bait 3 piece x



Rod Case J + Add-on Case x 1 storage example

7'~10' Yellowfin/GT x 2, Kingfish x 2, Big trout x 2, Sea bass x 3, Snakefish x 1, Jigging x 1

Fishing Rod Box

Once you get to the fishing point, don't you want to be ready and fishing as soon as possible? The INNO Rod Box fulfills such an angler's desire. Long rods with reels set up might not fit inside the car. If you have them perfectly set up and loaded in the rod box before you leave, you can just take them out and get started fishing!



ROD BOX 290 IF44BK

Rod-specific roof box with 3-step length adjustment and can hold a 9 ft. Rod with reel still set.
 Total length 7'9" to 9'7" Width 13.4", height 7.0"
 Weight 26.5 lbs
 Maximum load capacity 22 lbs
 Carry up to 8 rods



Short position(7'9") ~7'2" bass, trout, horse mackerel, rockfish



Medium position(8'8") ~8'1" tuna, bigfin reef squid, offshore fishing



Long position(9'7") ~9'0" sea bass, big trout, fly rod, offshore fishing



The rod is held when the cover is closed. Cushion with a dimpled surface prevents shock and movement while driving.



The spring damper makes opening the cover easier and keeps it open in a secure position.



The cover is fixed with three lever clamps. All levers are equipped with key locks.



Memory mount allows you to install or remove a Rod box in seconds making the use of the Rod box hassle free.



The main unit can be divided into three parts. Packaging size is 41.3" x 14.2" x 21.7"
 Total of 3 sides is 77.2"
 Weight is 35.3 lbs



IF49 T-Slot Adaptor

Stylish installation is assured with the unexposed mounting bracket.

FISHING ROD HOLDER

INNO Fishing rod holder can be stored inside the car. Because the Rod Holder itself is contoured to the curvature of the car interior roof, head space stays roomy and comfortable even when fishing rods are loaded.



GRAB HANDLE ADAPTOR

GRAB HANDLE MOUNT SYSTEM

- Our new mounting system for the Rod holder mounts directly on the grab handle without removing it.



Insert the assist pipe through the grab handle adaptor



Attach the frame of the rod holder to the fixed grab handle adaptor



IF62 Grab Handle adaptor
An adaptor that attaches the assist pipe to the grab handle

Rod holder Installable Conditions

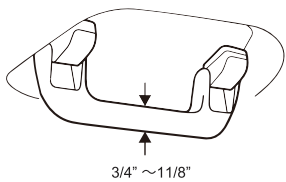

Grab handle must be movable, and diameter of the grip part must be 3/4" to 1 1/8 inches.

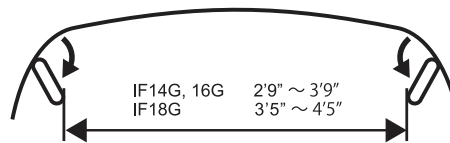

With the left and right side grab handles fully extended, measure the distance between the two. The spacing must be within the range in the figure on the left.

OPTIONS



• IF60

Frame set for short roof (Only for IF14 & IF16)
Replace this to fit Toyota Prius, Prius C & Subaru Cross Trek



• IF50BK

Option holder DH
Additional holder for the detachable dual holder

DUAL HOLD TYPE

- Compatible with 22 to 32mm grip diameter and 16mm on tip side
- Holder position is removable to front, rear, right, or left
- Freshwater, saltwater and fly rods can also be loaded
- IF62 Grab Handle Adaptor is included as standard feature



Dual holder can securely carry both 1 piece and 2 piece rods



Detachable and expandable
New construction holder can be installed and removed easily



Front holder is compatible with rear grip diameters up to 16mm and tip diameters up to 8mm



- IF16G Rod holder dual 5 (5 rods)
- Up to 7 holders can be mounted by adding IF50BK (sold separately)

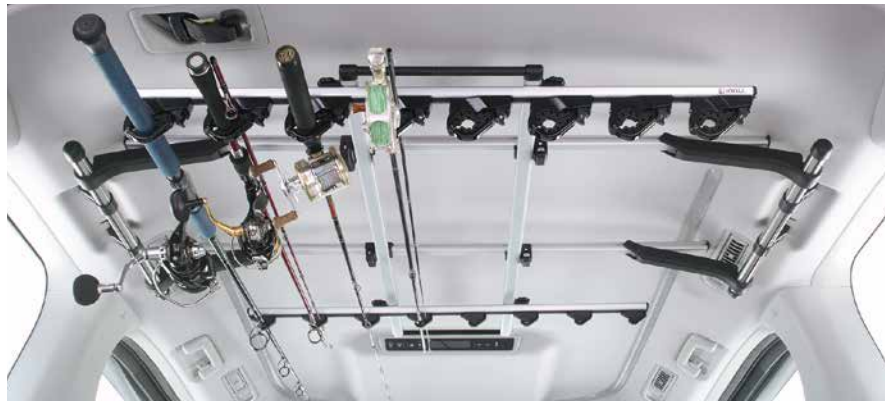

- IF18G Rod holder dual 8 wide (8 rods)
- Up to 10 holders can be mounted by adding IF50BK (sold separately)

J HOOK TYPE

- Compatible one piece, multi piece or gaffs
- Holder position is removable to front, rear, right, or left
- IF62 Grab Handle Adaptor is included as standard feature



New J hook design allows to carry small diameter tip



Front and Rear holder compatible with up to 32mm diameters. Can also carry



- IF14G Rod holder Jhook 7 (7 rods)
- For freshwater, saltwater and flyfishing rods

INNO ADVANCED CAR RACKS

A Division of Car Mate USA, Inc.

383 Van Ness Ave., Suite 1603 Torrance, CA 90501

310.533.9881

support@innoracks.com

www.innoracks.com

ISO 9001 and ISO 14001 Certified

HEADQUARTERS

Japan:

CAR MATE MFG. CO., LTD.

5-33-11 Nagasaki, Toshima-ku Tokyo 171-0051 Japan

81-3-5926-1226 ph. 81-3-5926-1227 fax int@carmate.co.jp



facebook.com/inno/advanced/car/racks



youtube.com/innoracks



instagram/innoracks

MEMBER

