



INH110 Installation instructions

INH120 Instructions d'installation

INH142 Instrucciones de instalación

INH110

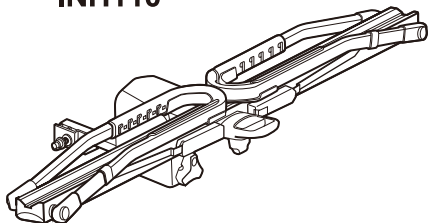

INH120

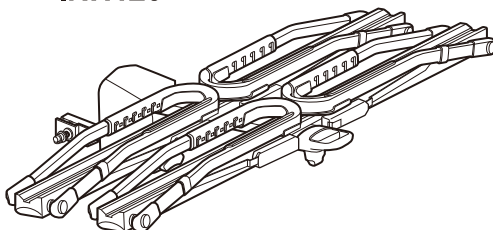

INH142

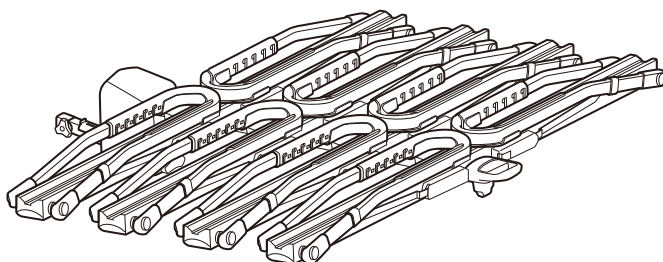

EN : Please be sure to follow the following matters for safe usage of this product.

 **Warning** Failure to follow this warning can result in serious accidents including death or serious injury.

 **Precautions** Failure to follow precautions can result in injury, damage to the product, vehicle, or load.

FR : Veuillez vous assurer de bien respecter les points suivants pour garantir une utilisation de ce produit en toute sécurité.

 **Avertissement** En cas de non-respect de cet avertissement, des accidents graves, entraînant des blessures graves ou la mort pourraient se produire.

 **Précautions** Le non-respect des précautions peut entraîner des blessures, ou encore endommager le produit, le véhicule ou la charge.

ES : Asegúrese de seguir las siguientes cuestiones para la utilización segura de este producto.

 **Advertencia** El no respetar esta advertencia puede ocasionar accidentes graves, incluso la muerte o heridas graves.

 **Precauciones** Si no sigue estas precauciones, pueden producirse heridas, daños al producto, al vehículo o a la carga.

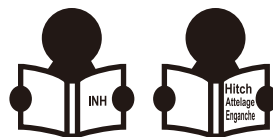

Loading Condition / Conditions de charge / Condiciones de carga

⚠ Warning ⚠ Avertissement ⚠ Advertencia

Possible installation size / Dimension possible d'installation / Tamaño de instalación posible

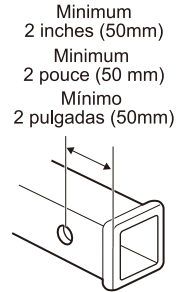
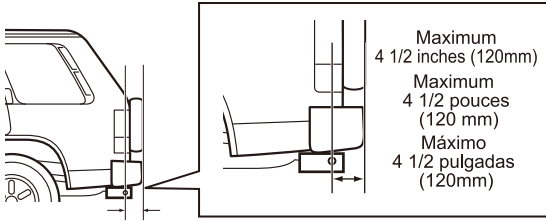

INH110

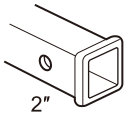

Max 60lbs.(27kg)

Class / Classe / Clase



INH120

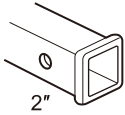

Max 60lbs.(27kg)



Max 120lbs.(54kg)

Class / Classe / Clase



INH142

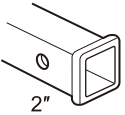

Max 60lbs.(27kg)



Max 160lbs.(72.5kg)

Class / Classe / Clase

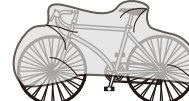
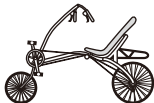
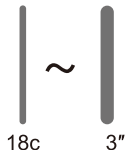
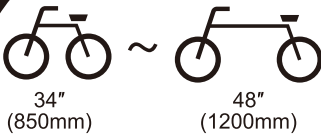

Product contents / Contenu du produit / Contenido del producto

No.	INH110	INH120	INH142
①	1	1	1
②	1	1	1
③	1	1	1
④	1	1	1
⑤	2	2	2
⑥	1	1	1
⑦	1	1	1
⑧	1	2	4
⑨	1	2	4
⑩	6	12	24
⑪	1	2	4
⑫	1	2	4

Preparation before installation / Préparation avant l'installation
Preparación antes de la instalación

1 INH110,120

EN : When the receiver size is 1 1/4 inches.
FR : Si le récepteur mesure 1 1/4 pouce.
ES : Cuando el tamaño del receptor es de 1 1/4 pulgadas.

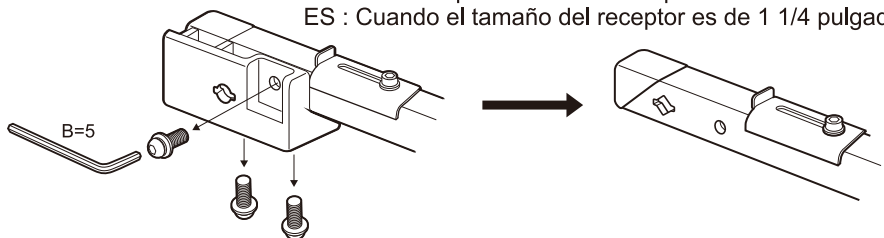

1 INH110,120

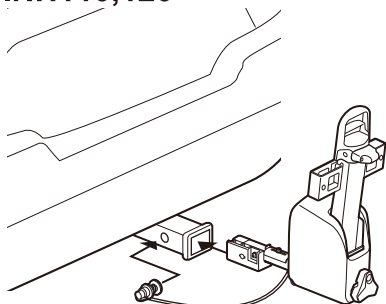

EN :  **Warning** Be sure to use safety pin.

FR :  **Avertissement** Assurez-vous d'utiliser une goupille de sécurité.

ES :  **Advertencia** Asegúrese de utilizar el pasador de seguridad.

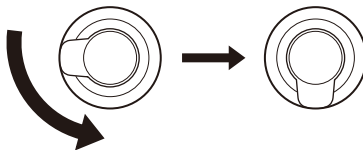

1 INH142

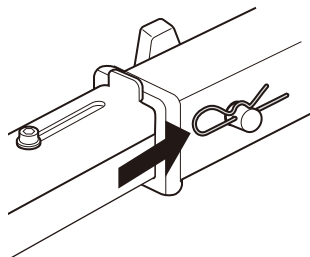
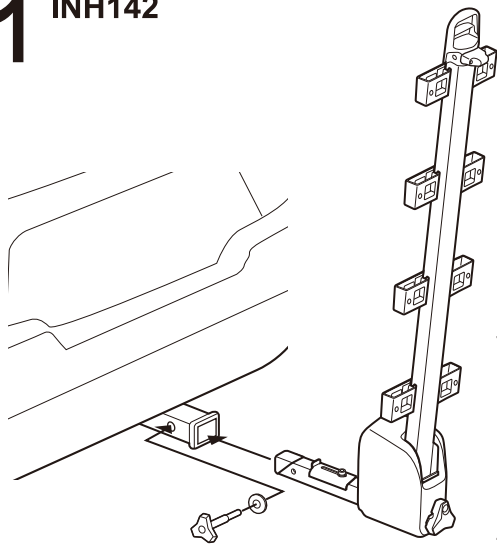

EN :  **Warning** Be sure to use safety bolt and snap pin.

FR :  **Avertissement** Assurez-vous d'utiliser le boulon de sécurité et la goupille d'arrêt.

ES :  **Advertencia** Asegúrese de utilizar el perno de seguridad y el pasador de retención.

2

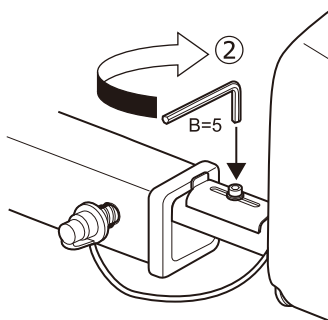
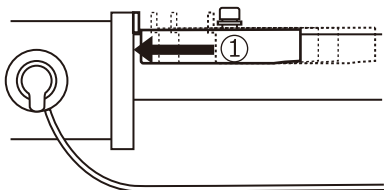

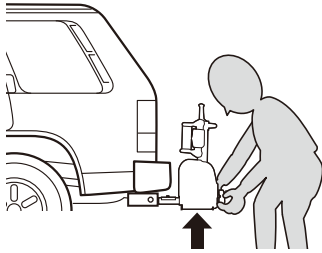
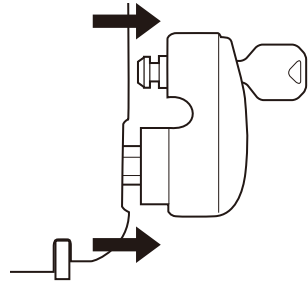
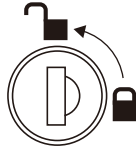
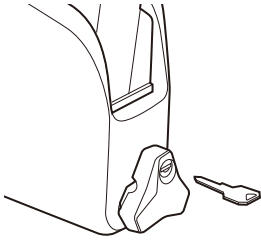

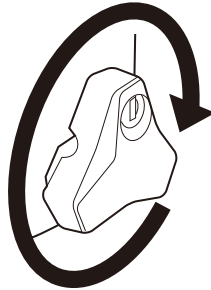

7.4ft-lb (10 N·m)
7.4pi-lb (10 N·m)



 Precautions

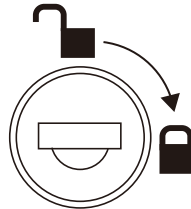
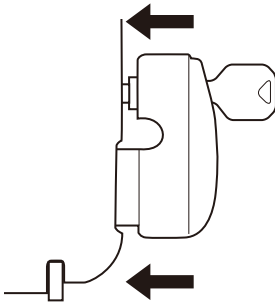

 Précautions

 Precauciones

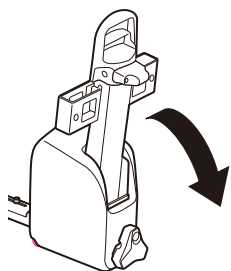

4



- EN :  **Warning** Confirm that red part must be invisible.
- FR :  **Avertissement** Vérifiez que la partie rouge doit être invisible.
- ES :  **Advertencia** Confirme que la parte roja no esté visible.

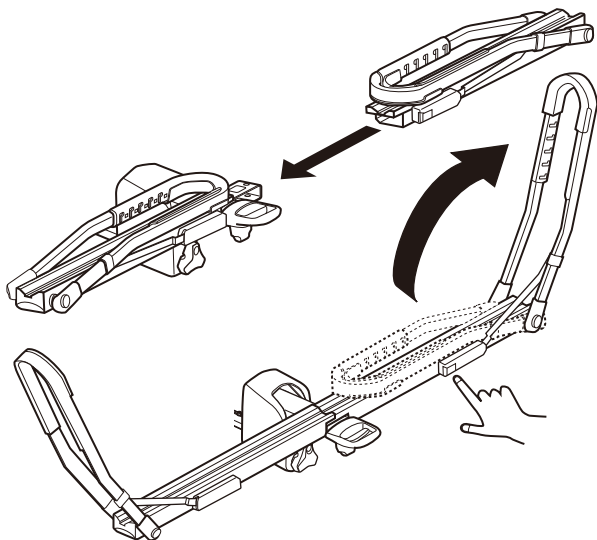
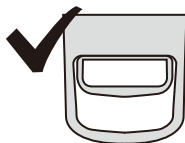

 7.4ft-lb (10 N·m) 7.4pi-lb (10 N·m)

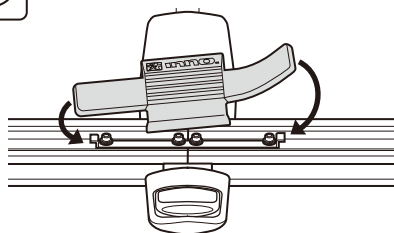
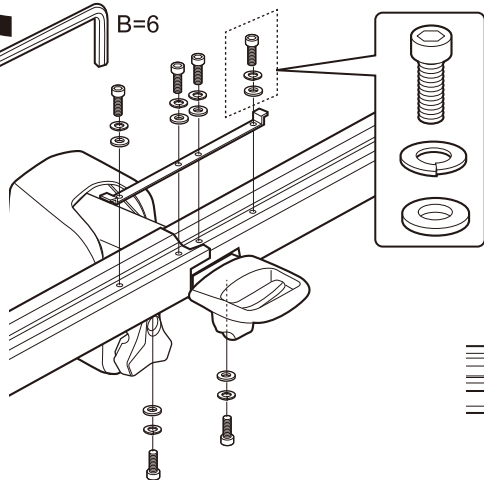

5

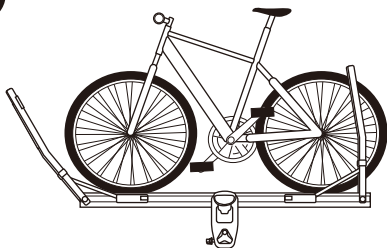

⚠ Precautions

⚠ Précautions

⚠ Precauciones

⚠ Precautions

⚠ Précautions

⚠ Precauciones

Heavy
Lourd
Pesado

Light
Léger
Liviano

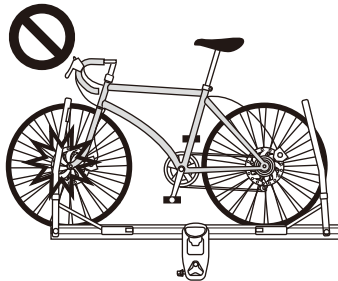
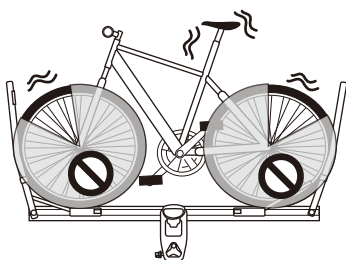
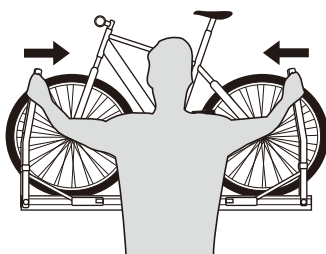
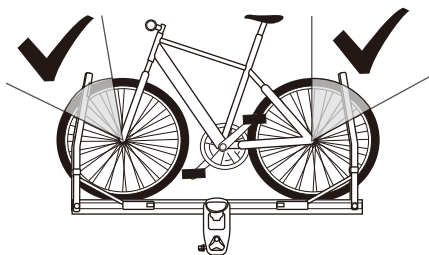
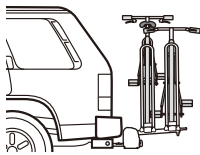

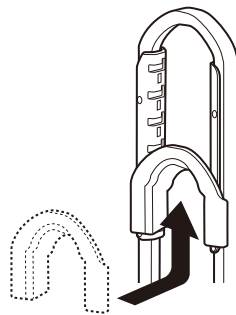
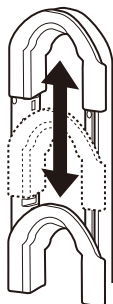
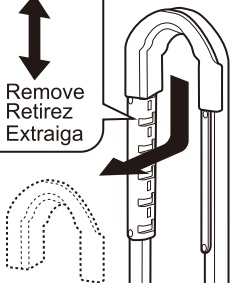

Lock
Verrou
Trabar

Remove
Retirez
Extraiga

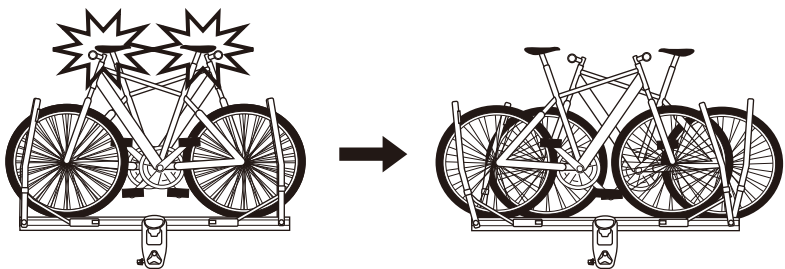



EN:  Warning Do not load a bike that exceeds the car width.

FR:  Avertissement Ne chargez pas un vélo qui dépasse la largeur de la voiture.

ES:  Advertencia No cargue una bicicleta que exceda el ancho del auto.

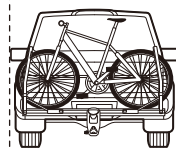
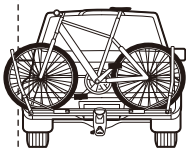

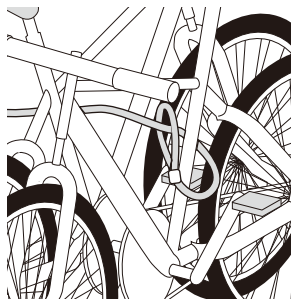
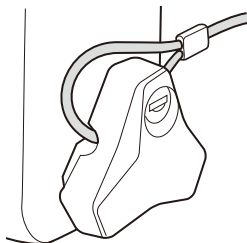

6

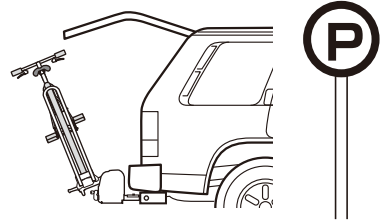
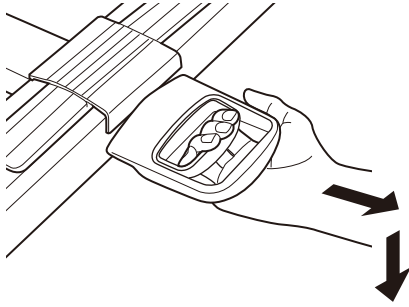

Tilt down / Inclinaison vers le bas / Inclinar hacia abajo



EN :  **Warning** Confirm that red part must be invisible.

FR :  **Avertissement** Vérifiez que la partie rouge doit être invisible.

ES :  **Advertencia** Confirme que la parte roja no esté visible.

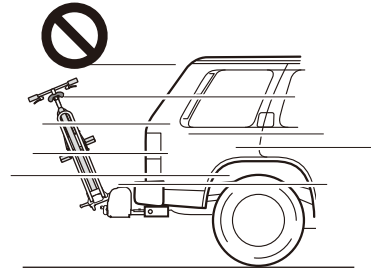

Spare parts / Pièces de rechange / Repuestos

EN : Please specify part name when ordering spare parts.

FR : Veuillez indiquer le nom de la pièce lors de la commande de pièces de rechange.

ES : Especifica el nombre de la pieza cuando pida repuestos.



EN : Hex wrench
FR : Clé hexagonale
ES : Llave hexagonal

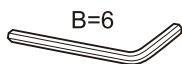

EN : Hex wrench
FR : Clé hexagonale
ES : Llave hexagonal



ISP 1066 (INH110-120)
ISP 1067 (INH142)
EN : Wire cable
FR : Câble métallique
ES : Cable



ISP 1068 (INH110. 120)
EN : Safty Pin
FR : Goupille de sécurité
ES : Pasador de seguridad



ISP 1069 (INH142)
EN : Safty Bolt
FR : Boulon de sécurité
ES : Perno de seguridad



EN : Cap Bolt M8 set
FR : Ensemble de caches boulons M8
ES : Conjunto de perno de tapa M8

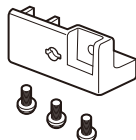

ISP 1070 (INH110. 120)
EN : Adapter
FR : Adaptateur
ES : Adaptador

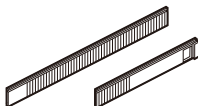

ISP 1071
EN : Ratchet rail
FR : Rail à cliquet
ES : Riel de trinquete



ISP 1072
EN : Bolt cover
FR : Couvercle de boulon
ES : Cubierta del perno



ISP 1073
EN : Tire adjuster
FR : Organe de réglage de pneu
ES : Ajustador de neumáticos

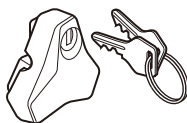

ISP 1074
EN : Knob
FR : Bouton
ES : Perilla

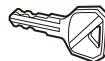

EN : Key
Key number is not changeable
FR : Clé
Le numéro de clé n'est pas modifiable
ES : Llave
El número de llave no es intercambiable



INH110 120 142
EN : Installation instruction
FR : Instructions d'installation
ES : Instrucciones de instalación



EN : Hitch Carriercommon Installation instruction
FR : Instructions d'installation générales pour porte-vélos d'attelage
ES : Instrucciones de instalación común del soporte de enganche

Contact Information / Coordonnées / Información de contacto

EN : We do not accept any liability for accidents, damage or injury caused by incorrect installation or use, modification, or natural disaster. Specifications and appearance of the carrier system and genuine replacement parts are subject to change without prior notice in the interest of product improvement.

FR : Nous ne pouvons être tenus responsables d'accidents, de dommages ou de blessures provoqués par une installation ou un usage incorrects, par une modification du dispositif ou par une catastrophe naturelle. Les spécifications et l'apparence du dispositif de support et des pièces de rechange authentiques sont sujettes à modification sans préavis pour fin d'amélioration du produit.

ES : No asumimos ninguna responsabilidad por accidentes, daños u otros perjuicios ocasionados por su incorrecta instalación, uso, modificación o por desastres naturales. Las especificaciones y apariencia del sistema y piezas de repuesto originales del portacargas están sujetas a cambio sin previo aviso en razón de mejora del producto.



CAR MATE USA, Inc.

383 Van Ness Ave., Suite 1603
Torrance, CA 90501
support@innoracks.com
www.innoracks.com

